

Solid State Relays Industrial, 1-Phase ZS (IO) w. LED Types RAM1A, RAM1B

CARLO GAVAZZI



- Zero switching (RAM1A) or instant-on switching (RAM1B) AC Solid State Relay
- Direct copper bonding (DCB) technology
- LED indication
- Clip-on IP 20 protection cover
- Self-lifting terminals
- Housing free of moulding mass
- 2 input ranges: 3-32 * and 20-280 VAC/22-48VDC
- Operational ratings: Up to 125AACrms and 690VACrms
- Blocking voltage: Up to 1600V_p
- Opto-isolation: > 4000VACrms
- Integrated overvoltage protection by self switching (suffix "Z" option)
- CE, RoHS compliant
- cURus, CSA, VDE, CCC

Product Description

The industrial, 1-phase relay with antiparallel thyristor output is the most widely used industrial SSR due to its multiple application possibilities. The relay can be used for resistive, inductive and capacitive loads. The zero switching relay switches ON when the sinusoidal curve crosses zero and switches OFF when the current cross-

es zero. The instant-on relay with DC control input can be used for phase angle control. The built-in snubber secures transient protection. The LED indicates the status of the control input. The clip-on cover secures touch protection (IP 20). Protected output terminals can handle cables up to 16 mm².

Ordering Key

RAM 1 A 60 D 125 Z

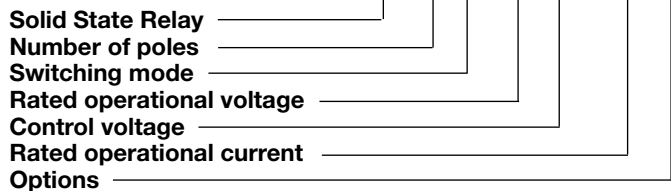

Type Selection

Switching mode	Rated operational voltage	Control voltage	Rated operational current	Options
A: Zero Switching B: Instant-on switching (DC Control only)	23: 230VACrms 60: 600VACrms 69: 690VACrms	A: 20-280 VAC/22-48VDC D: 3 - 32VDC*	25 : 25AACrms 50 : 50AACrms 75 : 75AACrms 100:100AACrms 125:125AACrms	Z: Overvoltage protection (self-switching)
		* 4 to 32VDC for RAM1A60..., RAM1A69... * 4 to 32VDC for RAM1B types		

Selection Guide

Rated operational voltage	Blocking voltage	Control voltage	Rated operational current				
			25A	50A	75A	100A	125A
230VACrms	650V _p	3 - 32VDC	RAM1A23D25	RAM1A23D50	RAM1A23D75	RAM1A23D100	RAM1A23D125
		20-280VAC/22-48VDC	RAM1A23A25	RAM1A23A50	RAM1A23A75	RAM1A23A100	RAM1A23A125
600VACrms	1200V _p	4 - 32VDC	RAM1A60D25	RAM1A60D50	RAM1A60D75	RAM1A60D100	RAM1A60D125
		20-280VAC/22-48VDC	RAM1A60A25	RAM1A60A50	RAM1A60A75	RAM1A60A100	RAM1A60A125
690VACrms	1600V _p	4-32VDC	-	-	RAM1A69D75	RAM1A69D100	RAM1A69D125
		20-280VAC/ 22-48VDC	-	-	RAM1A69A75	RAM1A69A100	RAM1A69A125

Options

1 Overvoltage protection by self-switching: add suffix Z to include. Example: RAM1A60D25Z. Not applicable for 690V version.

General Specifications

	RAM1.23..	RAM1.60..	RAM1.69..
Operational voltage range			
RAM1A...	24 to 265VACrms	42 to 660VACrms	42 to 760VACrms
RAM1B...	42 to 265VACrms	42 to 660VACrms	42 to 760VACrms
Blocking voltage	$\geq 650V_p$	$\geq 1200V_p$	$\geq 1600V_p$
Zero voltage turn-on	$\leq 10V$	$\leq 10V$	$\leq 10V$
Operational frequency range	45 to 65Hz	45 to 65Hz	45 to 65Hz
Power factor	$> 0.5 @ 230VACrms$	$> 0.5 @ 600VACrms$	$> 0.5 @ 690VACrms$
Approvals	UR, cUR, CSA, VDE*, CCC	UR, cUR, CSA, VDE*, CCC	CCC
CE-marking	Yes	Yes**	Yes**
Isolation			
Input to Output	4000 Vrms	4000 Vrms	4000 Vrms
Input and Output to case	4000 Vrms	4000 Vrms	4000 Vrms

* VDE0805

** Heatsink must be connected to ground

Input Specifications

	RAM1...D..	RAM1...A..
Control voltage range		
RAM1A23...	3-32VDC	20-280VAC, 22-48VDC
RAM1A60..., RAM1A69...	4-32VDC	20-280VAC, 22-48VDC
RAM1B...	4-32VDC	-
Pick-up voltage @ Ta = 25°C		
RAM1A23...	2.5VDC	18VAC/DC
RAM1A60..., RAM1A69...	3.5VDC	18VAC/DC
RAM1B...	3.5VDC	-
Reverse voltage	32VDC	-
Drop out voltage	1.2VDC	6VAC/DC
Input current @ max input voltage		
RAM1A	12mA	20mA
RAM1B	15mA	-
Response time pick-up		
RAM1A	1/2 cycle	12ms
RAM1B	0.1ms	-
Response time drop-out	1/2 cycle	40ms

Output Specifications

	RAM1...25	RAM1...50	RAM1...75	RAM1...100	RAM1...125
Rated operational current					
AC51 @ Ta=25°C	25Arms	50Arms	75Arms	100Arms	125Arms
AC53a @ Ta=25°C	5Arms	15Arms	17Arms	20Arms	30Arms
Min. operational current	150mA	250mA	400mA	400mA	500mA
Rep. overload current t=1 s	$< 55AACrms$	$< 125AACrms$	$< 130 AACrms$	$< 150 AACrms$	$< 200AACrms$
Non-rep. surge current t=10 ms	325A _p	600A _p	800A _p	1150A _p	1900A _p
Off-state leakage current @ rated voltage and frequency	$< 3mArms$	$< 3mArms$	$< 3mArms$	$< 3mArms$	$< 3mArms$
I ² t for fusing t= 10 ms	$< 525A^2s$	$< 1800A^2s$	$< 3200A^2s$	$< 6600A^2s$	$< 18000A^2s$
On-state voltage drop	$\leq 1.6Vrms$	$\leq 1.6Vrms$	$\leq 1.6Vrms$	$\leq 1.6Vrms$	$\leq 1.6Vrms$
Critical dV/dt off-state min.	1000V/μs	1000V/μs	1000V/μs	1000V/μs	1000V/μs
Endurance testing acc. to UL 508	100,000 cycles	100,000 cycles	100,000 cycles	6,000 cycles	6,000 cycles

Note: UL requirement for General Use Endurance Testing is 6,000 cycles

Motor Ratings*: HP (UL508)

	230VAC	400VAC	480VAC	600VAC
RAM1..25	1.5HP	3HP	3HP	5HP
RAM1..50	3HP	5HP	7.5HP	10HP
RAM1..75	5HP	7.5HP	10HP	15HP
RAM1..100	7.5HP	15HP	20HP	25HP
RAM1..125	10HP	15HP	25HP	30HP

* with suitable heatsink

Electromagnetic Compatibility

Immunity	IEC/EN 61000-6-2	Radiated Radio Frequency Immunity	IEC/EN 61000-4-3
Electrostatic Discharge (ESD)		10V/m, 80 - 1000 MHz	Performance Criteria 1
Immunity	IEC/EN 61000-4-2	10V/m, 1.4 - 2.0GHz	Performance Criteria 1
Air discharge, 8kV	Performance Criteria 2	3 V/m, 2.0 - 2.7GHz	Performance Criteria 1
Contact, 4kV	Performance Criteria 2	Conducted Radio Frequency Immunity	IEC/EN 61000-4-6
Electrical Fast Transient (Burst) Immunity	IEC/EN 61000-4-4	10V/m, 0.15 - 80 MHz	Performance Criteria 1
Output: 2kV, 5kHz	Performance Criteria 1	Voltage Dips Immunity	IEC/EN 61000-4-11
Input: 1kV, 5kHz	Performance Criteria 1	0% for 0.5 / 1 cycle	Performance Criteria 2
Electrical Surge Immunity	IEC/EN 61000-4-5	70% for 500ms	Performance Criteria 2
Output, line to line, 2kV	Performance Criteria 2	Voltage Interruptions Immunity	IEC/EN 61000-4-11
Output, line to earth, 1kV	Performance Criteria 2	0% for 5000ms	Performance Criteria 2
Output, line to earth, 2kV	Performance Criteria 2 with external varistor		
Input, line to line, 1kV	Performance Criteria 2		
Input, line to earth, 2kV	Performance Criteria 2		
EMC Emission	IEC/EN 61000-6-4	Radio Interference	
Radio Interference		Field Emission (Radiated)	IEC/EN 55011
Voltage Emission (Conducted)	IEC/EN 55011	30 - 1000MHz	Class B
0.15 - 30MHz	Class A (industrial) with filters IEC/EN 60947-4-3 Class A (no filtering needed up to 75AAC)		





Notes:

- Control input lines must be installed together to maintain products' susceptibility to Radio Frequency interference.
- Performance Criteria 1: No degradation of performance or loss of function is allowed when the product is operated as intended.
- Performance Criteria 2: During the test, degradation of performance or partial loss of function is allowed. However, when the test is complete the product should return operating as intended by itself.
- Performance Criteria 3: Temporary loss of function is allowed, provided the function can be restored by manual operation of the controls.

Housing Specifications

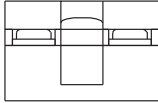
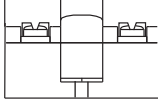
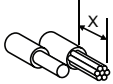
Weight 25A, 50A 75A, 100A, 125A	Approx. 60g Approx. 100g	Relay Mounting screws Mounting torque	M5 1.5-2.0Nm
Housing material	Noryl, black	Control terminal Mounting screws Mounting torque	M3 x 9 0.5Nm
Baseplate 25A, 50A 75A, 100A, 125A	Aluminium Copper, nickel-plated	Power terminal Mounting screws Mounting torque	M5 x 9 2.4Nm

Connection Specifications

Connection terminals	L1, T1	A1, A2			
					
Stripping length (X)	12 mm	8 mm			
Connection Type	M5 screw with captivated washer	M3 screw with captivated washer			
Rigid (solid & stranded) UR rated data		1x 2.5 - 6.0 mm ² 1x 14 - 10 AWG	2x 2.5 - 6.0 mm ² 2x 14 - 10 AWG	1x 0.5 - 2.5 mm ² 1x 18 - 12 AWG	2x 0.5 - 2.5 mm ² 2x 18 - 12 AWG
Flexible with end sleeve		1x 1.0 - 4.0 mm ² 1x 18 - 12 AWG	2x 1.0 - 2.5 mm ² 2x 2.5 - 4.0 mm ² 1x 18 - 14 AWG 1x 14 - 12 AWG	1x 0.5 - 2.5 mm ² 1x 18 - 12 AWG	2x 0.5 - 2.5 mm ² 1x 18 - 12 AWG
Flexible without end sleeve		1x 1.0 - 6.0 mm ² 1x 18 - 10 AWG	2x 1.0 - 2.5 mm ² 2x 2.5 - 6.0 mm ² 1x 18 - 14 AWG 1x 14 - 10 AWG		
Torque specification		Pozidrive 2 2.4 Nm (21.2 lb-in)	Pozidrive 1 0.5 Nm (4.4 lb-in)		
Aperture for termination lug		12 mm	7.5 mm		

Functional Diagram

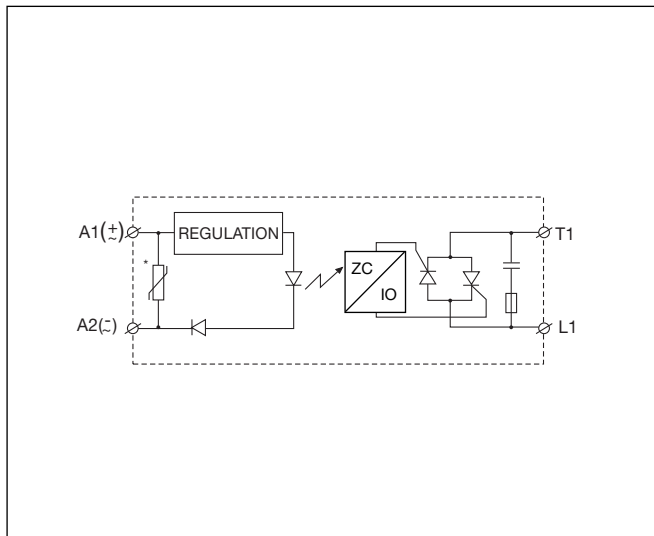

* Varistor across input applies to AC control versions only.

Dimensions

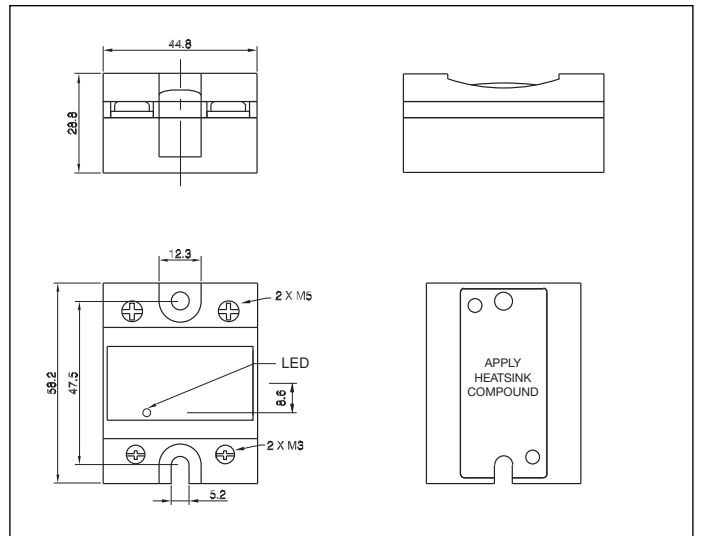

All dimensions in mm.

Connection Diagram

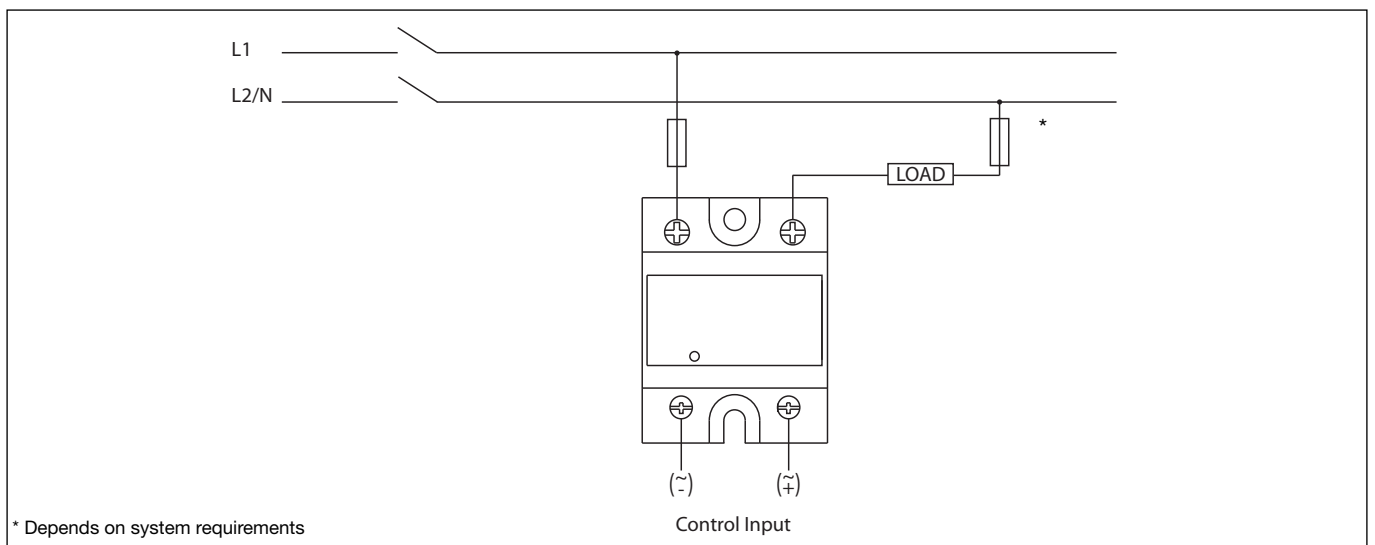

* Depends on system requirements



Heatsink Dimensions (load current versus ambient temperature)

RAM..25

Load current [A]	Thermal resistance [°C/W]							Power dissipation [W]
	20	30	40	50	60	70	80	
25.0	3.23	2.80	2.37	1.94	1.51	1.09	0.66	23
22.5	3.70	3.21	2.73	2.24	1.75	1.26	0.78	21
20.0	4.30	3.74	3.17	2.61	2.05	1.49	0.92	18
17.5	5.07	4.41	3.76	3.10	2.44	1.78	1.12	15
15.0	6.12	5.33	4.54	3.75	2.96	2.17	1.38	13
12.5	7.58	6.61	5.64	4.66	3.69	2.72	1.75	10
10.0	9.80	8.55	7.30	6.05	4.80	3.55	2.30	8
7.5	13.5	11.80	10.09	8.37	6.66	4.94	3.23	6
5.0	-	18.3	15.7	13.04	10.39	7.74	5.09	4
2.5	-	-	-	-	-	16.2	10.7	2

Ambient temp. [°C]

RAM..50

Load current [A]	Thermal resistance [°C/W]							Power dissipation [W]
	20	30	40	50	60	70	80	
50.0	1.25	1.07	0.88	0.70	0.52	0.34	0.16	55
45.0	1.46	1.25	1.04	0.84	0.63	0.42	0.21	48
40.0	1.73	1.49	1.25	1.01	0.77	0.52	0.28	41
35.0	2.08	1.80	1.51	1.23	0.94	0.66	0.37	35
30.0	2.56	2.22	1.87	1.53	1.18	0.84	0.49	29
25.0	3.24	2.81	2.38	1.95	1.52	1.09	0.66	23
20.0	4.26	3.71	3.15	2.59	2.03	1.47	0.92	18
15.0	5.99	5.22	4.45	3.67	2.90	2.12	1.35	13
10.0	9.49	8.27	7.06	5.85	4.64	3.43	2.22	8
5.0	-	17.5	15.0	12.4	9.91	7.39	4.86	4

Ambient temp. [°C]

Junction to ambient thermal resistance, $R_{th\ j-a}$	< 20.0	°C/W
Junction to case thermal resistance, $R_{th\ j-c}$	< 0.80	°C/W
Case to heatsink thermal resistance, $R_{th\ c-s^2}$	< 0.20	°C/W
Maximum allowable case temperature	100	°C
Maximum allowable junction temperature	125	°C

Junction to ambient thermal resistance, $R_{th\ j-a}$	< 20.0	°C/W
Junction to case thermal resistance, $R_{th\ j-c}$	< 0.50	°C/W
Case to heatsink thermal resistance, $R_{th\ c-s^2}$	< 0.20	°C/W
Maximum allowable case temperature	100	°C
Maximum allowable junction temperature	125	°C

RAM..75

Load current [A]	Thermal resistance [°C/W]							Power dissipation [W]
	20	30	40	50	60	70	80	
75.0	0.94	0.82	0.70	0.58	0.47	0.35	0.23	85
67.5	1.10	0.96	0.82	0.69	0.55	0.41	0.27	73
60.0	1.30	1.14	0.98	0.81	0.65	0.49	0.33	61
52.5	1.57	1.38	1.18	0.98	0.79	0.59	0.39	51
45.0	1.95	1.70	1.46	1.22	0.97	0.73	0.49	41
37.5	2.48	2.17	1.86	1.55	1.24	0.93	0.62	32
30.0	3.32	2.90	2.49	2.07	1.66	1.24	0.83	24
22.5	4.75	4.15	3.56	2.97	2.37	1.78	1.19	17
15.0	7.68	6.72	5.76	4.80	3.84	2.88	1.92	10
7.5	-	14.59	12.50	10.42	8.34	6.25	4.17	5

Ambient temp. [°C]

RAM..100

Load current [A]	Thermal resistance [°C/W]							Power dissipation [W]
	20	30	40	50	60	70	80	
100.0	0.60	0.52	0.43	0.34	0.26	0.17	0.09	117
90.0	0.74	0.64	0.54	0.44	0.34	0.24	0.14	101
80.0	0.91	0.79	0.68	0.56	0.45	0.33	0.22	87
70.0	1.09	0.96	0.82	0.68	0.55	0.41	0.27	73
60.0	1.33	1.16	1.00	0.83	0.66	0.50	0.33	60
50.0	1.66	1.45	1.24	1.04	0.83	0.62	0.41	48
40.0	2.16	1.89	1.62	1.35	1.08	0.81	0.54	37
30.0	3.01	2.64	2.26	1.88	1.51	1.13	0.75	27
20.0	4.73	4.14	3.55	2.96	2.37	1.78	1.18	17
10.0	9.94	8.70	7.45	6.21	4.97	3.73	2.48	8

Ambient temp. [°C]

Junction to ambient thermal resistance, $R_{th\ j-a}$	< 20.0	°C/W
Junction to case thermal resistance, $R_{th\ j-c}$	< 0.35	°C/W
Case to heatsink thermal resistance, $R_{th\ c-s^2}$	< 0.10	°C/W
Maximum allowable heatsink temperature	100	°C
Maximum allowable junction temperature	125	°C

Junction to ambient thermal resistance, $R_{th\ j-a}$	< 20.0	°C/W
Junction to case thermal resistance, $R_{th\ j-c}$	< 0.35	°C/W
Case to heatsink thermal resistance, $R_{th\ c-s^2}$	< 0.10	°C/W
Maximum allowable heatsink temperature	100	°C
Maximum allowable junction temperature	125	°C



Heatsink Dimensions (cont.)

Thermal Specifications

RAM..125

Load current [A]	Thermal resistance [°C/W]							Power dissipation [W]
	20	30	40	50	60	70	80	
125.0	0.63	0.55	0.47	0.40	0.32	0.24	0.16	126
112.5	0.73	0.64	0.54	0.45	0.36	0.27	0.18	110
100.0	0.84	0.74	0.63	0.53	0.42	0.32	0.21	95
87.5	0.99	0.87	0.74	0.62	0.50	0.37	0.25	81
75.0	1.20	1.05	0.90	0.75	0.60	0.45	0.30	67
62.5	1.48	1.30	1.11	0.93	0.74	0.56	0.37	54
50.0	1.92	1.68	1.44	1.20	0.96	0.72	0.48	42
37.5	2.65	2.32	1.98	1.65	1.32	0.99	0.66	30
25.0	4.12	3.60	3.09	2.57	2.06	1.54	1.03	19
12.5	8.55	7.48	6.41	5.34	4.27	3.21	2.14	9

Ambient temp. [°C]

Operating temperature	-40° to +80°C (-40° to +176°F)
Storage temperature	-40° to +100°C (-40° to +212°F)
Junction temperature	≤ 125°C (257°F)

Junction to ambient thermal resistance, $R_{th\ j-a}$	< 20.0	°C/W
Junction to case thermal resistance, $R_{th\ j-c}$	< 0.30	°C/W
Case to heatsink thermal resistance, $R_{th\ c-s}$	< 0.10	°C/W
Maximum allowable heatsink temperature	100	°C
Maximum allowable junction temperature	125	°C

Note: Thermal resistance case to heatsink valves are applicable upon application of a fine layer of silicon based thermal paste HTS02S from Electrolube between SSR and heatsink.

Heatsink Selection

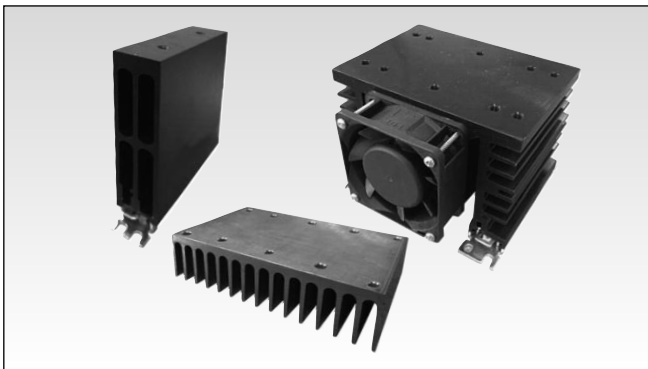

Ordering Key

RHS..

- Heatsinks and fans
- 5.40°C/W to 0.12°C/W thermal resistance
- DIN, panel or thru wall mounting
- Single or multiple SSR mounting

Heatsink Range Overview:

http://www.productselection.net/PDF/UK/ssr_accessories.pdf

Heatsink Selector Tool:

<http://www.productselection.net/heatsink/heatsinkselector.php?LANG=UK>

Short Circuit Protection

Protection Co-ordination, Type 1 vs. Type 2:

Type 1 protection implies that after a short circuit, the device under test will no longer be in a functioning state. In type 2 co-ordination the device under test will still be functional after the short circuit. In both cases, however, the short circuit has to be interrupted. The fuse between enclosure and supply shall not open. The door or cover of the enclosure shall not be blown open. There shall be no damage to conductors of terminals and the conductors shall not separate from terminals. There shall be no breakage or cracking of insulating bases to the extent that the integrity of the mounting of live parts is impaired. Discharge of parts or any risk of fire shall not occur.

The product variants listed in the table hereunder are suitable for use on a circuit capable of delivering not more than 65,000A rms Symmetrical Amperes, 600Volts maximum when protected by fuses. Tests at 65,000A were performed with Class J, fast acting: please refer to the table below for maximum allowed ampere rating of the fuse. Use fuses only.

Co-ordination type 1 (UL508)

Type	Potential circuit current [kArms]	Maks. størrelse [A]	Klasse	Spænding [VAC]
RAM1..25..	65	30	J / CC	600
RAM1..50..	65	30 20	J HSJ20 (Mersen*)	600 600
RAM1..75..	65	100	J	600
RAM1..100..	65	80 60	J HSJ60 (Mersen*)	600 600
RAM1..125..	65	125 60	J HSJ60 (Mersen*)	600 600

Co-ordination type 2 (IEC/EN60947-4-3)

Part No.	Prospective short circuit current [kArms]	Max. fuse size [A]	Brand	Model	Size
RAM1.23..25..	10	25	Mersen*	6.9gRB 10-25	10.3 x 38
RAM1.60..25..	10	20	Mersen*	6.9gRB 10-20	10.3 x 38
RAM1.23..50..	10	50	Mersen*	6.9zz CP gRC 14x51/50	14 x 51
RAM1.60..50..	10	50	Mersen*	6.9zz CP gRC 22x58/50	22 x 58
RAM1.xx.75.. (xx = 23 or 60)	10	63	Mersen*	6.9zz CP gRC 22x58/63	22 x 58
RAM1.23.100..	10	100	Mersen*	6.9zz CP gRC 22x58/100	22 x 58
RAM1.60.100..	10	80	Mersen*	6.9zz CP gRC 22x58/80	22 x 58
RAM1.xx.125.. (xx = 23 or 60)	10	125	Mersen*	6.921 CP URGD 27x60/125	27 x 60

zz = 00, without fuse trip indication

zz = 21, with fuse trip indication

* Formerly Ferraz Shawmut

Type 2 Protection with Miniature Circuit Breakers (M.C.B.s)

Solid State Relay type	ABB Model no. for Z - type M. C. B. (rated current)	ABB Model no. for B - type M. C. B. (rated current)	Wire cross sectional area [mm ²]	Minimum length of Cu wire conductor [m]*	
RAM..25..	1-pole				
	S201-Z4 (4A)	S201-B2 (2A)	1.0	21.0	
	S201-Z6 UC (6A)	S201-B2 (2A)	1.0	21.0	
			1.5	31.5	
RAM..50..	1-pole				
	S201-Z10 (10A)	S201-B4 (4A)	1.0	7.6	
			1.5	11.4	
			2.5	19.0	
	S201-Z16 (16A)	S201-B6 (6A)	1.0	5.2	
			1.5	7.8	
			2.5	13.0	
			4.0	20.8	
	S201-Z20 (20A)	S201-B10 (10A)	1.5	12.6	
			2.5	21.0	
	S201-Z25 (25A)	S201-B13 (13A)	2.5	25.0	
			4.0	40.0	
		2-poles			
		S202-Z25 (25A)	S202-B13 (13A)	2.5	19.0
			4.0	30.4	
RAM..75.. RAM..100..	1-pole				
	S201-Z20 (20A)	S201-B10 (10A)	1.5	4.2	
			2.5	7.0	
			4.0	11.2	
	S201-Z32 (32A)	S201-B16 (16A)	2.5	13.0	
			4.0	20.8	
			6.0	31.2	
		2-poles			
		S202-Z20 (20A)	S202-B10 (10A)	1.5	1.8
				2.5	3.0
	4.0			4.8	
	S202-Z32 (32A)	S202-B16 (16A)	2.5	5.0	
			4.0	8.0	
			6.0	12.0	
			10.0	20.0	
	S202-Z50 (50A)	S202-B25 (25A)	4.0	14.8	
6.0			22.2		
10.0			37.0		
RAM..125..	1-pole				
	S201-Z50 (50A)	S201-B25 (25A)	4.0	4.8	
			6.0	7.2	
			10.0	12.0	
			16.0	19.2	
	S201-Z63 (63A)	S201-B32 (32A)	6.0	7.2	
			10.0	12.0	
			16.0	19.2	

* Between MCB and Load (including return path which goes back to the mains).

Note: A prospective current of 6kA and a 230/400V power supply system is assumed for the above suggested specifications. For cables with different cross section than those mentioned above please consult Carlo Gavazzi's Technical Support Group.



FASTON terminals



- Faston tabs
- Tab dimensions according to DIN 46342 part 1
- Pure tin-plated brass

Ordering Key

Screw mounted Faston terminals

RAM1A60D25 | **F 4** *

RAM Solid State Relay _____
Faston terminals _____
Tab orientation _____

Input Tab width: 4.8mm
Output Tab width: 6.3mm

Faston terminals in packs of 20

RM48 ** | **F4** *

RS, RM Solid State Relay _____
Tab orientation _____

* 0: Flat (0°)
4: Angled (45°)

** 48: 4.8mm faston for input
63: 6.3mm faston for output

Fork Terminals

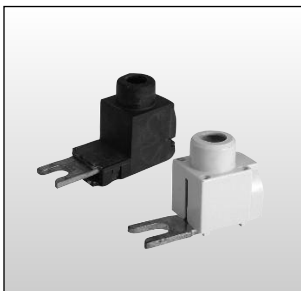

- Terminal adaptors for 35mm² cable
- Type RM635FK
- Pack size: 20 pieces

Ordering Key

RM635FK | **P**

RM terminal adaptor _____
Touch protected (optional) _____

Other Accessories

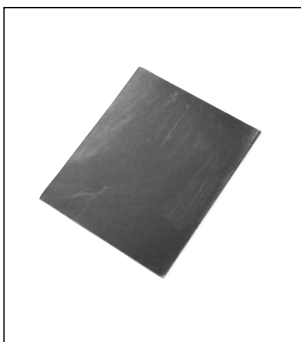

- Graphite thermal pad with adhesive on one side
- Type KK071CUT
- Dimensions: 35 x 43 x 0.25mm
- Packing quantity: 50pcs.



- Touch safety cover
- Type RMIP20
- IP20 protection degree
- Pack size: 20 pieces

All accessories can be ordered pre-assembled with Solid State Relays.
Other accessories include DIN rail adaptors, fuses, varistors and spacers.

For further information refer to Accessories datasheets at:
www.productselection.net/PDF/UK/SSR_Accessories.pdf